

Cross Section Drawing

Tuscany Sliding Door, 4 Panel Accessory Groove Frame, 2 1/4" Contour Z-Bar



Clearly the best.

CAD File Scale
NTS

View
Horizontal & Vertical

File Name
8621T-06 SD

Units
Inch

More Technical Documents can be found at milgard.com/professionals
Due to continual research and development, details may be changed at any time. ©2013 Milgard Mfg.

SLIDING DOOR SERIES 8621

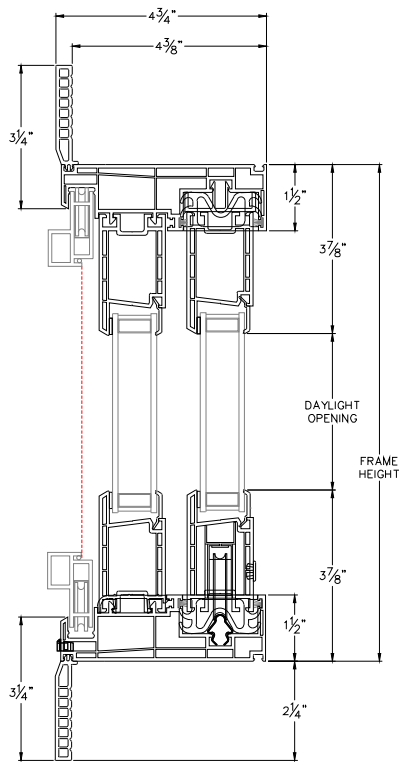

HEAD & SILL

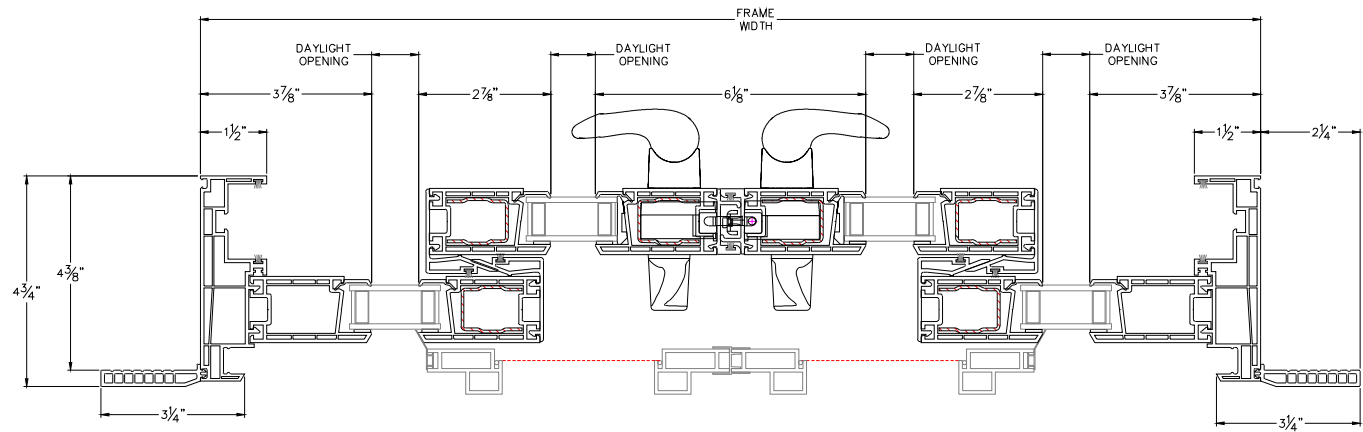

JAMBS