

Cross Section Drawing
AX550 Bi-Fold Doors 5L0R Tall Sill
Block Frame



Clearly the best.™

CAD File Scale	View	File Name	Units	Revision
NTS	Horizontal & Vertical	AX550_11621_BI_5L0R_Tall_Sill_Block	Inch	02/2021

More Technical Documents can be found at milgard.com/professionals
 Due to continual research and development, details may be changed at any time. ©2021 Milgard Mfg.

BI-FOLD
SERIES 11621

Configuration 5L0R shown
 Configuration 0L5R also available

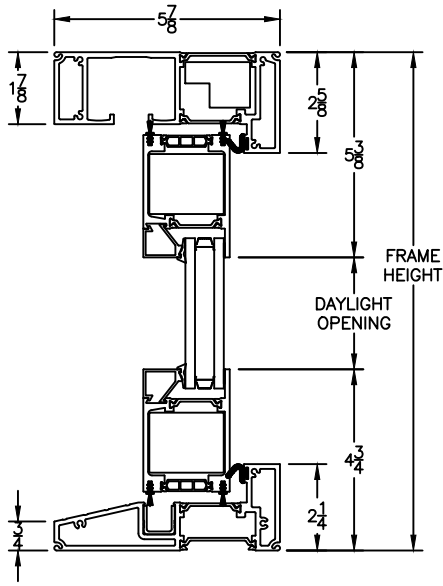

HEAD & SILL

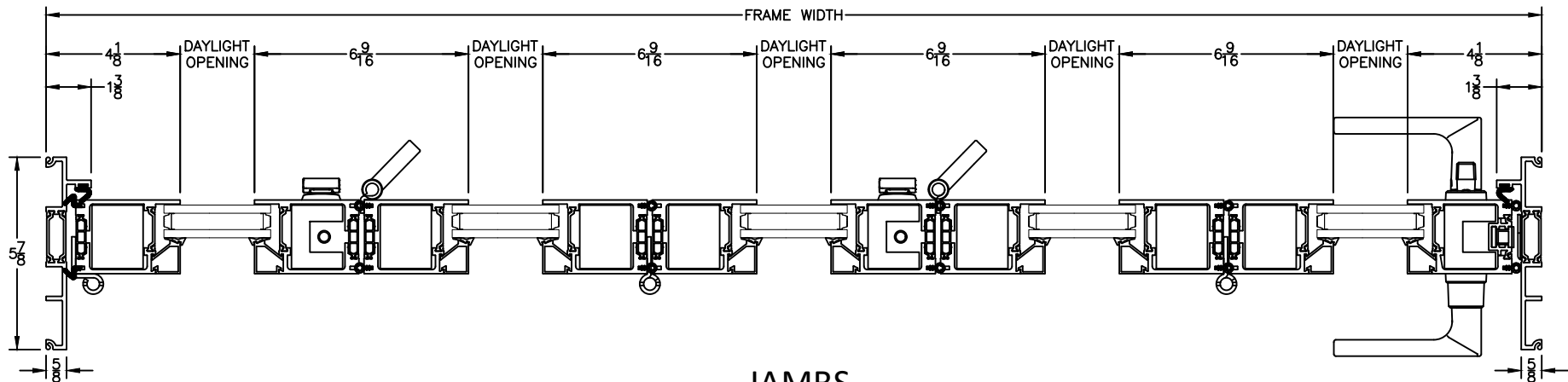

JAMBS