

Cross Section Drawing

Tuscany Outswing Door 1 3/8" Nailfin Setback, 4 9/16" Wall Condition



Clearly the best.™

CAD File Scale
NTS

View
Horizontal & Vertical

File Name
8643 VOS_X_1375in

Units
Inch

More Technical Documents can be found at milgard.com/professionals

Due to continual research and development, details may be changed at any time. ©2013 Milgard Mfg.

OUTSWING DOOR SERIES 8643

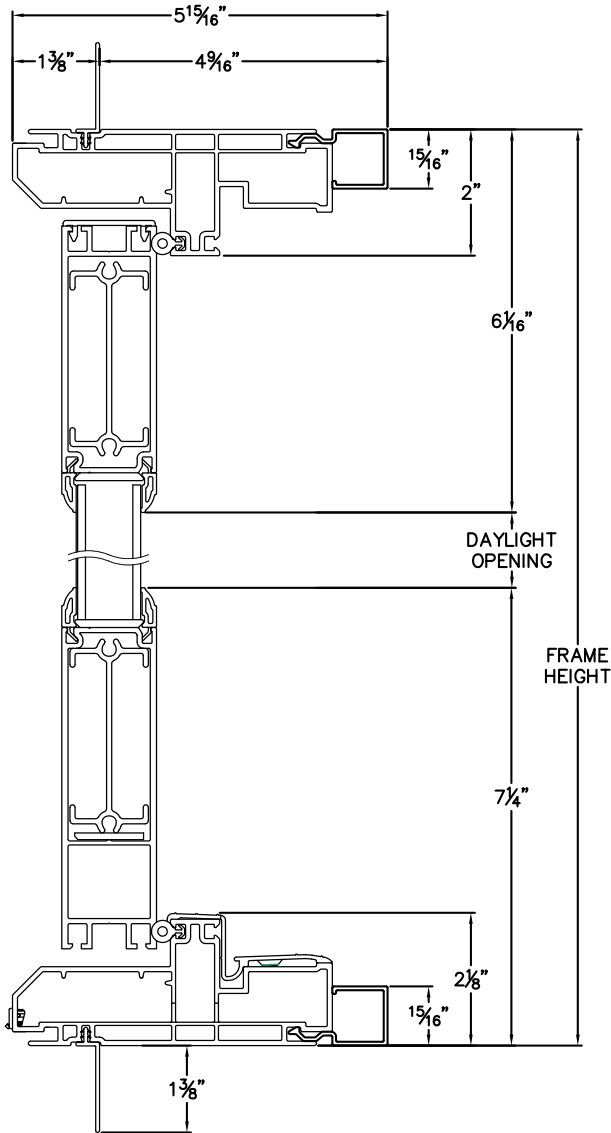

HEAD & SILL

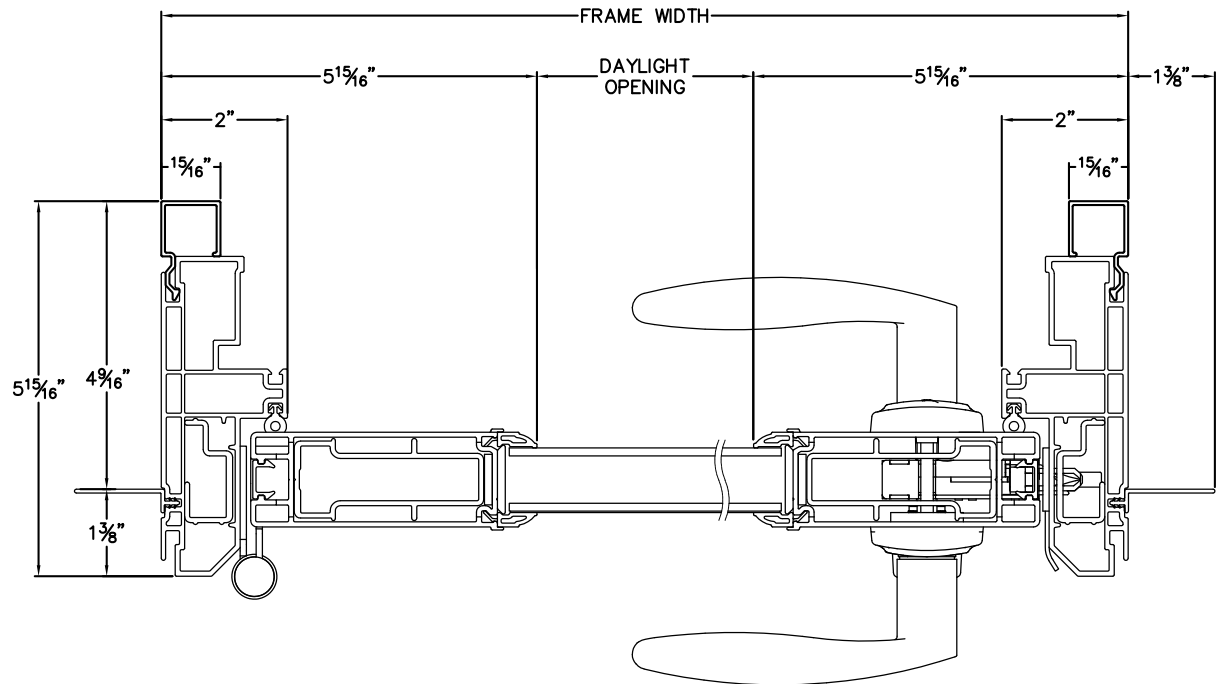

JAMBS