

Cross Section Drawing

Tuscany Inswing Door 1" Nailfin Setback, 6 15/16" Wall Condition



Clearly the best.™

CAD File Scale
NTS

View
Horizontal & Vertical

File Name
Tuscany_8662_VIS_X_1in

Units
Inch

Revision
7/2024

More Technical Documents can be found at milgard.com/professionals

Due to continual research and development, details may be changed at any time. ©2024 Milgard Mfg.

INSWING DOOR SERIES 8662

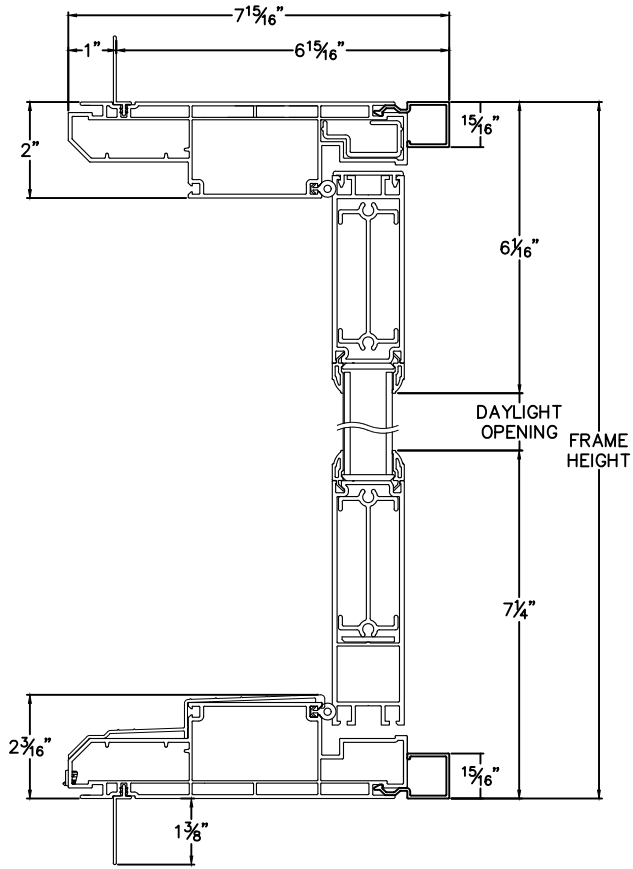

HEAD & SILL

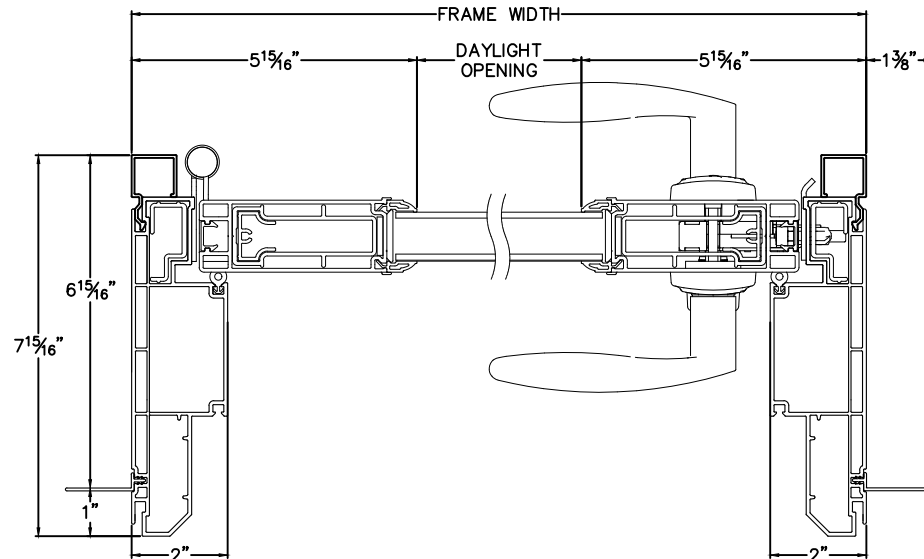

JAMBS