

Cross Section Drawing

Tuscany Sliding Door, 4 Panel 1" Fin Setback



Clearly the best.

CAD File Scale
NTS

View
Horizontal & Vertical

File Name
8631T-02 SD

Units
Inch

More Technical Documents can be found at milgard.com/professionals
Due to continual research and development, details may be changed at any time. ©2013 Milgard Mfg.

SLIDING DOOR SERIES 8631

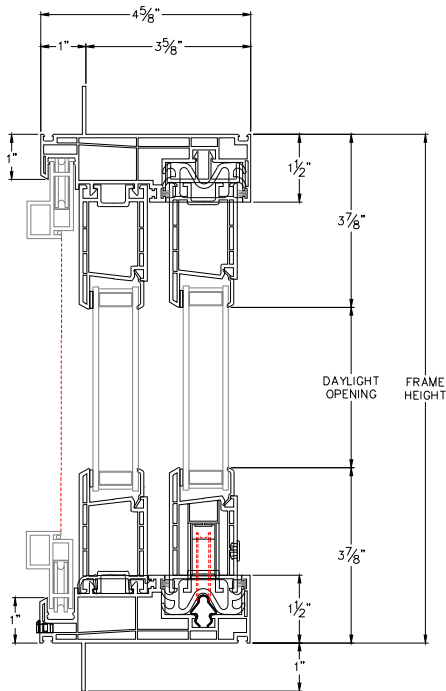

HEAD & SILL

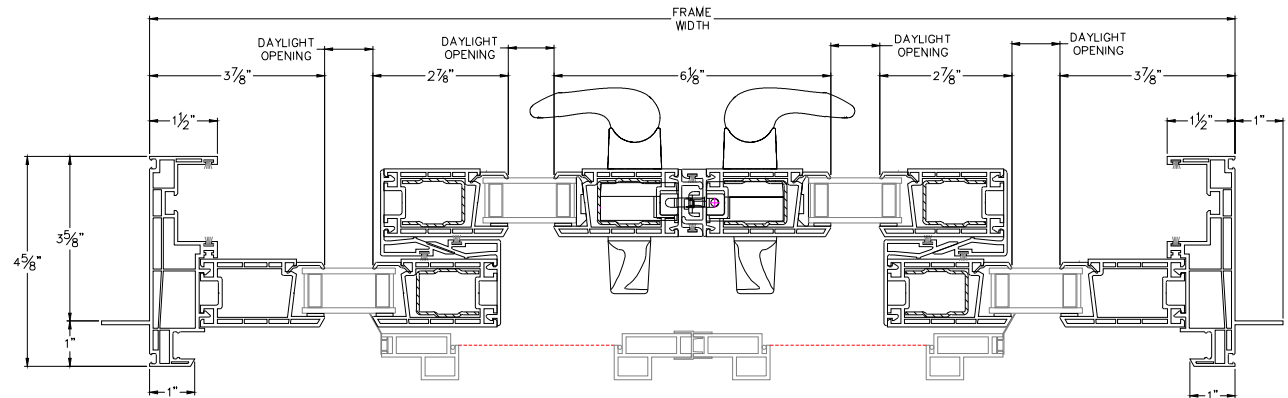

JAMBS