

Cross Section Drawing

Ultra Horizontal Double Vent Window 2 1/4" Contour Z-Bar



CAD File Scale
NTS

View
Horizontal & Vertical

File Name
3110U-05 DV

Units
Inch

More Technical Documents can be found at milgard.com/professionals
Due to continual research and development, details may be changed at any time. ©2013 Milgard Mfg.

HORIZONTAL DOUBLE VENT SERIES 3110

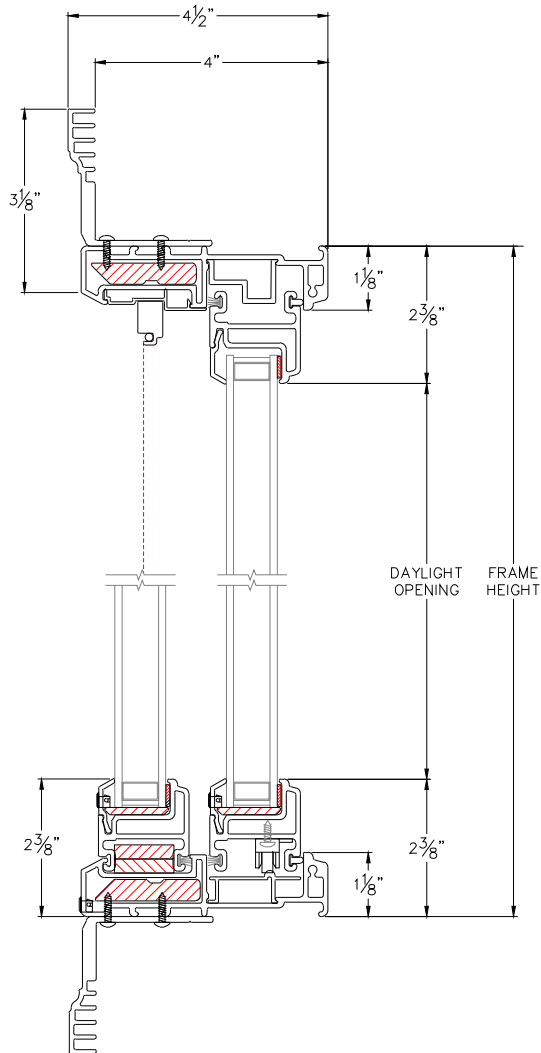

HEAD & SILL

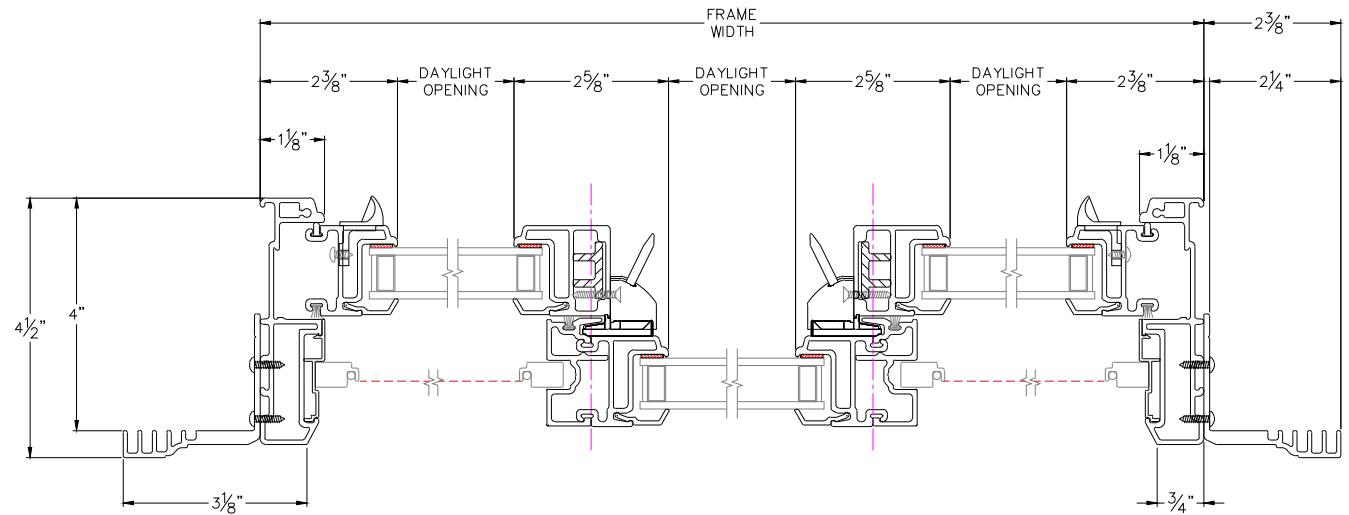

JAMBS