

CROSS SECTION DRAWING

Ultra French OutSwing Door, 2 Panel w/ Operable Sidelites

1 3/4" Contour Z Bar



CAD FILE SCALE	VIEW	FILE NAME	UNITS	REVISION
NTS	HORIZONTAL & VERTICAL	Ultra_3645_OS_HAPH_1.75in-z-bar	INCH	09/2016

MORE TECHNICAL DOCUMENTS CAN BE FOUND AT MILGARD.COM/PROFESSIONALS
 DUE TO CONTINUAL RESEARCH AND DEVELOPMENT, DETAILS MAY BE CHANGED AT ANY TIME. © 2016 MILGARD MFG.

OUTSWING SERIES 3645

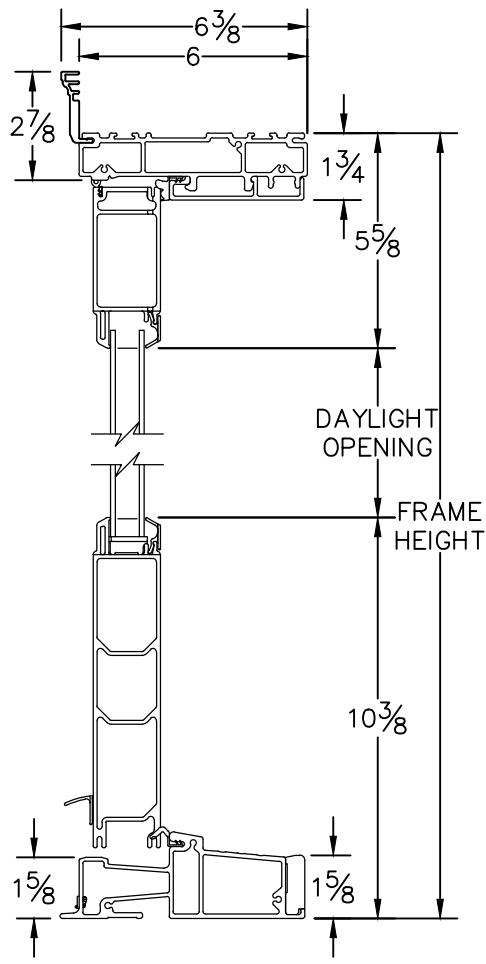

HEAD & SILL

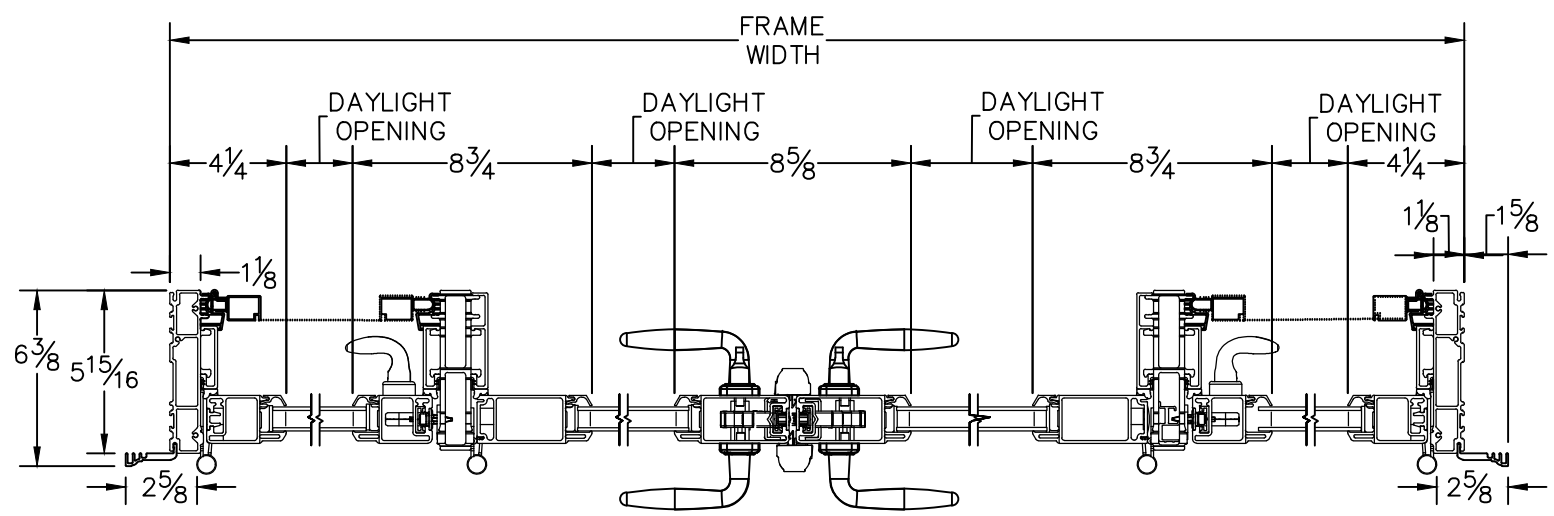

JAMBS