

Cross Section Drawing

Trinsic Full Casement Window Block Frame (No Fin)



Clearly the best.™

CAD File Scale
NTS

View
Horizontal & Vertical

File Name
Trinsic_2510_FC_block

Units
Inch

Revision
2/2020

More Technical Documents can be found at milgard.com/professionals
Due to continual research and development, details may be changed at any time. ©2020 Milgard Mfg.

CASEMENT SERIES 2510

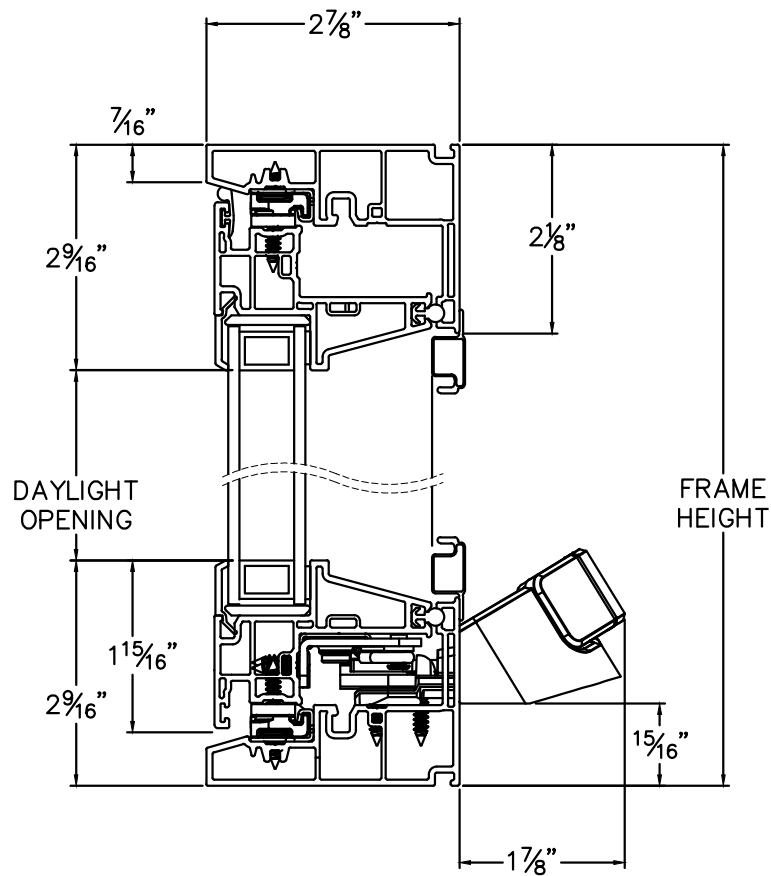

HEAD & SILL

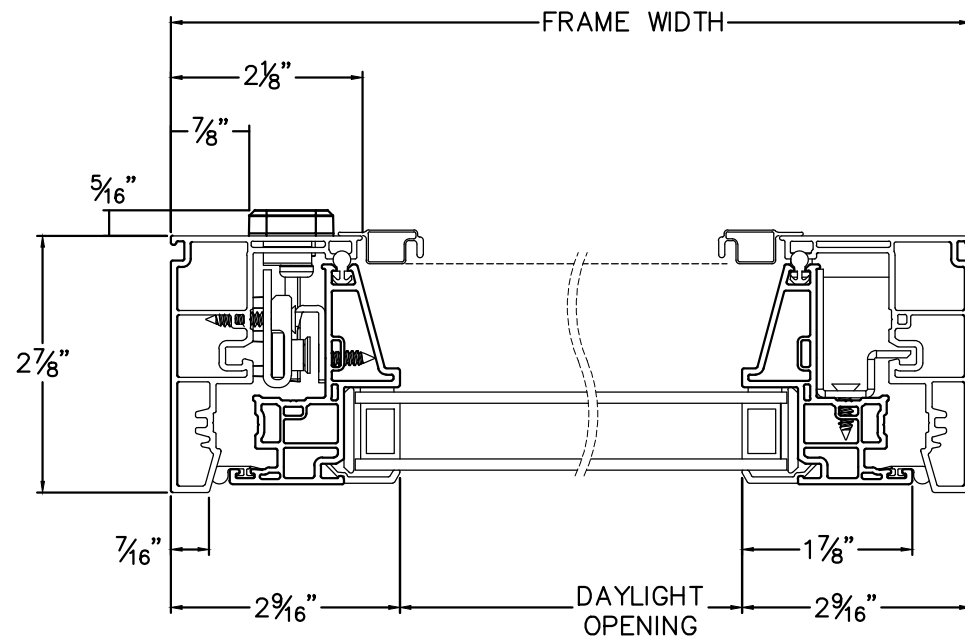

JAMBS